

LZ-фланцевый тип

LZ Series Metallic Tube Variable-area Flowmeter

General

LZ series variable-area flowmeter with metallic measuring tube has the characteristics of simplicity, reliability, wide application field, high precision and easy installation. Compared variable-area flowmeter with glass tube flow meter, this series has the characteristics of high pressure safe, high temperature safe, easy reading etc. It is widely applicable in petrol, chemical, power supply, pharmacy, food, water treatment industry etc.

Connection Type



Construction

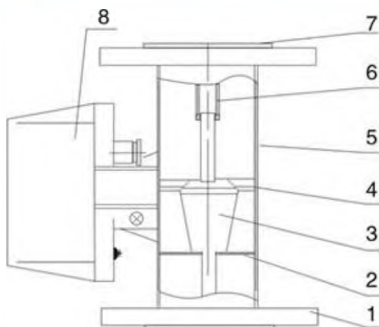

Main Technical Parameters

Measure Range	Water (20°C) (2.5-10000) L/h Air (20°C, 1.101325MPa) (0.07-750) m³/h
Range Ratio	10:1
Accuracy Grade	±1.5%, ±2.5%
Fluid Working Pressure	DN15-DN50: 4.0MPa DN80-DN150: 1.6MPa
Working Pressure of Coating	1.6MPa
Fluid Working Temperature	-80°C~+200°C (PTFE≤+85°C) (For Model PTFE≤+85°C)
Connection Type	(Flange connection, Threaded connection or Tri-clamp connection flange refer to standard GB/T9119; ANSI 150lbs, 300lbs; HG20592-20635; Other standard flange can be made to the user requirement.)
Environment Temperature	-25°C~+55°C
Medium Viscidity	DN15≤5mPa.S; DN25-DN100≤250mPa.S
Electricity Singal Output	Output Signal: (4-20mA)
	Linear Accuracy: 1%
	Temperature Influence : 0.5%/10°C
Restrict Alarm	Power Supply : (13-30) V DC
	Power Supply Consume : ≤250mW
Explosion-proof Gr	Power Supply : 24 (±10%) V DC
	Power Loss : ≤3W
	Working Temperature: -25°C~+60°C
	EXIBICT5

1 Flange Connection	5 Tube Body
2 Guider	6 Stopper
3 Float	7 Spring Collar
4 Measuring Tube	8 Indicator

По вопросам продаж и поддержки обращайтесь:

Архангельск (8182)63-90-72
Астана +7(7172)727-132
Астрахань (8512)99-46-04
Барнаул (3852)73-04-60
Белгород (4722)40-23-64
Брянск (4832)59-03-52
Владивосток (423)249-28-31
Волгоград (844)278-03-48
Вологда (8172)26-41-59
Воронеж (473)204-51-73
Екатеринбург (343)384-55-89
Иваново (4932)77-34-06
Ижевск (3412)26-03-58
Иркутск (395) 279-98-46
Киргизия (996)312-96-26-47

Казань (843)206-01-48
Калининград (4012)72-03-81
Калуга (4842)92-23-67
Кемерово (3842)65-04-62
Киров (8332)68-02-04
Краснодар (861)203-40-90
Красноярск (391)204-63-61
Курск (4712)77-13-04
Липецк (4742)52-20-81
Магнитогорск (3519)55-03-13
Москва (495)268-04-70
Мурманск (8152)59-64-93
Набережные Челны (8552)20-53-41
Нижегород (831)429-08-12
Казахстан (772)734-952-31

Новокузнецк (3843)20-46-81
Новосибирск (383)227-86-73
Омск (3812)21-46-40
Орел (4862)44-53-42
Оренбург (3532)37-68-04
Пенза (8412)22-31-16
Пермь (342)205-81-47
Ростов-на-Дону (863)308-18-15
Рязань (4912)46-61-64
Самара (846)206-03-16
Санкт-Петербург (812)309-46-40
Саратов (845)249-38-78
Севастополь (8692)22-31-93
Симферополь (3652)67-13-56
Таджикистан (992)427-82-92-69

Смоленск (4812)29-41-54
Сочи (862)225-72-31
Ставрополь (8652)20-65-13
Сургут (3462)77-98-35
Тверь (4822)63-31-35
Томск (3822)98-41-53
Тула (4872)74-02-29
Тюмень (3452)66-21-18
Ульяновск (8422)24-23-59
Уфа (347)229-48-12
Хабаровск (4212)92-98-04
Челябинск (351)202-03-61
Череповец (8202)49-02-64
Ярославль (4852)69-52-93

Эл. почта: zau@nt-rt.ru || Сайт: <https://zyia.nt-rt.ru/>

LZ Series Metallic Tube Variable-area Flowmeter

Model Selection

Metallic Tube Variable-area Flowmeter	
Z	Local indicator
D	Local indicator with 4-20MA output
DE	LCD display with 4-20MA output
DN15-150	Pipe Size(mm)
Connection type	
F	Flange connection(ANSI150lbs)
C	Tri-clamp connection
S	Threaded connection
Structure Form	
Y10	Bottom - top
Y20	Right - left or left - right (Horizontal)
Y30	In and out on the same side
Y40	In and out on different side
Y50	Bottom - side
Contacting Liquid	
RRO	316/ oCr18Ni 12 Mo2Ti
RR1	304/ 1Cr18 Ni9Ti
RL	316L
RP	PTFE
Ti	Titanium
HC	Hastelloy C
Indicator	
1	Aluminum alloy
2	All stainless steel
3	Flame - proof type
Power Supply	
D1	DV24V power supply
D2	Battery power supply
N	N/A
Alarm	
K1	High alarm limit(HA)
K2	Low alarm limit(LA)
K12	One HA and LA
N	N/A
Additional Function	
T	Jacket type
Z	Damp type
B	Flame-proof type
H	Hart
N	N/A

Selection Example

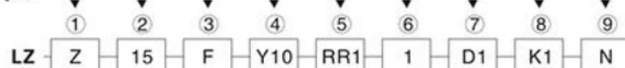

Measuring Range

Diameter (mm)	Water (L/h) 20°C 101325Pa		Air (m³/h) 20°C 101325Pa.abs			Maximum Pressure Loss (Kpa)				Accuracy	Working Pressure	
	RRO	RR1 RL	PTFE	RRO	RR1	RL	RRO	RR1	RL			PTFE
15	1.6-16			0.05-0.5			6.5				± 1.5%	≦ 4.0Mpa
	2.5-25			0.07-0.7			6.5					
	4-40	2.5-25		0.12-1.2			6.5		5.5			
	6-60	4-40		0.18-1.8			6.6		5.5			
	10-100	6-60		0.3-3			6.6		5.6			
	16-160	10-100		0.4-4.0			6.8		5.8			
	25-250	16-160		0.7-7.0			7.2		6.1			
	40-400	25-250		1.0-10			8.6		6.1			
	60-600	40-400		1.5-15			11.1		7.3			
	80-800	60-600		2.5-25			11.1		7.3			
20	100-1000	80-800		3.0-30			11.1		7.3			
	40-400	40-400		0.75-7.5			8.6		6.1			
	60-600	60-600		1.2-12			11.1		7.3			
25	100-1000	100-1000		1.8-18			11.1		7.3			
	40-400	40-400		1-10			6.5		5.9			
	60-600	50-500		1.5-15			6.5		6.2			
	80-800	60-600		2.5-25			7.0		7.0			
	100-1000	80-800		4-40			7.0		5.9			
	160-1600	100-1000		5-50			8.0		6.0			
	250-2500	160-1600		6-60			10.8		6.8			
	400-4000	250-2500		8-80			15.8		9.2			
	500-5000	400-4000		10-100			16.2		11.0			
	600-6000	500-5000		15-150			16.5		12.0			
32	160-1600	160-1600		3.0-30			8.0		6.0			
	250-2500	250-2500		5.0-50			10.8		6.8			
	400-4000	400-4000		7.5-75			15.8		9.2			
	600-6000	600-6000					16.5		12.0			
40	400-4000	400-4000		3.0-30			8.0		6.5			
	600-6000	600-6000		5.0-50			11		6.8			
	1000-10000	1000-10000		7.5-75			16.2		9.4			
50	600-6000	400-4000		18-180			8.0		6.5			
	1000-10000	600-6000		25-250			11.0		6.8			
	1600-16000	1000-10000		40-400			16.2		9.4			
	2000-20000	1600-16000		50-500			17.0		14.5			
	2500-25000	2000-20000		60-600			19.0		16.5			
65	1200-12000	1200-12000		18-180			8.2		6.9			
	1600-16000	1600-16000		30-300			8.2		6.9			
	2500-25000	2500-25000		37-370			15.5		11.9			
80	1600-16000	1000-10000		50-500			8.2		6.9			
	2500-25000	1600-16000		60-600			15.5		11.9			
	4000-40000	2000-20000		100-1000			20.0		16.1			
	5000-50000	2500-25000		150-1500			25.0		18.1			
100	4000-40000	2000-20000		100-1000			8.4		8.1			
	5000-50000	2500-25000		150-1500			11.2		9.1			
	6000-60000	4000-40000		180-1800			20.0		16.5			
	8000-80000	5000-50000		240-2400			25.4		22.2			
	10000-100000	8000-80000		300-3000			32		29.2			
125	10000-100000	8000-80000		300-3000			42		38.5			
	25000-125000	10000-100000					45		42			
150	12500-125000	10000-100000					45		42			
	15000-150000	12500-125000					60		58			

Note:1.To ensure flowmeter working stability,it should be assured that working pressure not less than double of max loss of pressure when flowmeter used to measure liquid ;when you measured medium is air, it should be assured that working pressure not less than five times of max loss of pressure;2.Above measuring range is for reference only , you can select other measuring ranges according to range ratio 10:1; 3.Flowmeter can be special made for you as per medium density ,viscosity , temperature ,pressure and other parameters you supply.

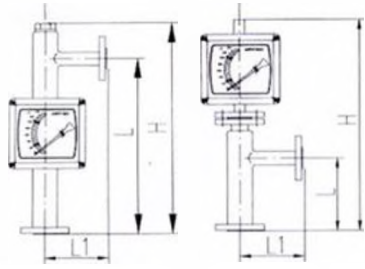

Y50 Bottom-Side
(DN15-25)

Y50 Bottom-Side
(DN50-100)

DN	H	L	L1
15	350	250	120
20	350	250	120
25	350	250	120
32	350	250	120
40	350	250	120
50	600	250	120
65	600	250	120
80	700	250	150
100	700	250	150

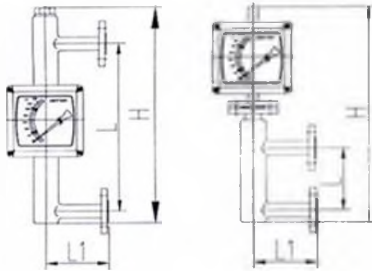

Y30 In and on
the Same Side
(DN15-25)

Y30 In and on
the Same Side
(DN50-100)

DN	H	L	L1
15	500	250	120
20	500	250	120
25	500	250	120
32	500	250	120
40	500	250	120
50	650	250	120
65	650	250	120
80	800	300	150
100	800	300	150

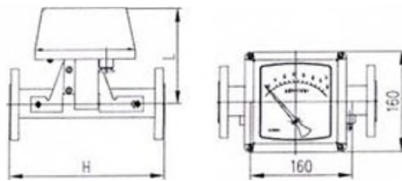

Y20 Right-left. Left-right
(Horizontal)

DN	H	L
15	250	160
20	250	160
25	250	160
32	250	160
40	250	160
50	250	160
65	250	160
80	250	160
100	250	160
125	250	160
150	300	160

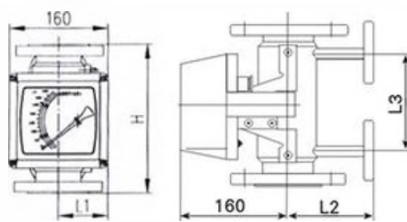

Jacket Flange Connection

DN	H	L1	L2	L3
15	250	84	116	150
20	250	84	116	150
25	250	95	128	150
32	250	99	132	150
40	250	99	132	150
50	250	111	144	150
65	250	111	144	150
80	250	130	183	150
100	250	146	179	150

LZ Series Metallic Tube Variable-area Flowmeter

LZ- Outline and installing dimension (Flange Connection)

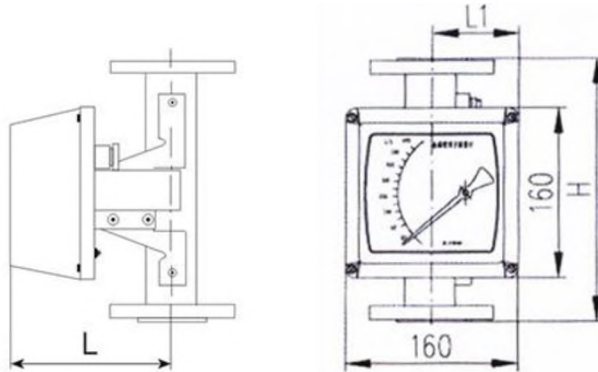

Y10 Bottom-top



DN	H	L	L1
15	250	160	80
20	250	160	80
25	250	160	89
32	250	160	91
40	250	160	91
50	250	160	104
65	250	160	104
80	250	160	130
100	250	160	137
125	250	160	137
150	300	160	157

LZ Series Metallic Tube Variable-area Flowmeter

Flange And Outline Dimensions

Cliber/Pressure mm/MPa	Size (mm)						
	Φd	Φd3	Φk	Φd2	b	f	L
15/4.0	95	45	65	4-Φ14	16	2	250
25/4.0	115	68	85	4-Φ14	18	2	250
50/4.0	165	102	125	4-Φ18	20	3	250
80/1.6	200	138	160	4-Φ18	20	3	250
100/1.6	220	162	180	4-Φ18	20	3	250
125/1.6	250	188	210	4-Φ18	22	3	250
150/1.6	285	218	240	4-Φ22	22	3	300

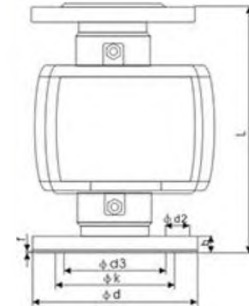

Magnet Fliter

If medium might having been mixed with freemagnet particles, installation of relevant filters turns essential. Hekucal positioning pattern of the filtering sticks reduces pressure loss to the maximum. Each filtering magnetic stick has been coated with PTFE, which protects the sticks from corrosion.

Type I : (flange connetion) Height:100mm

Type II : (compacted installation) Height:50mm

Magnet Fliter

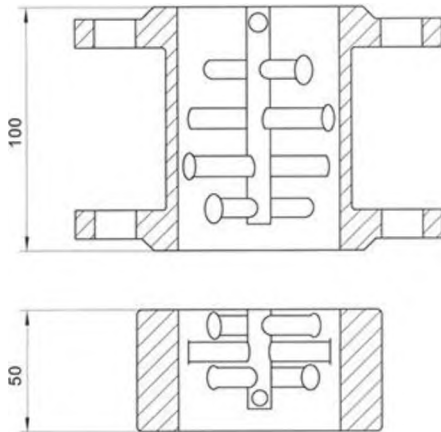

Oscilator Damper

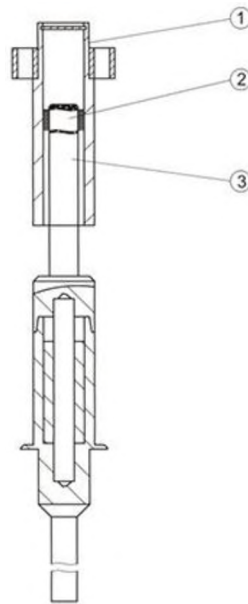

- ① — Tube of Oscilator Damper
- ② — Oscilator Damper
- ③ — Float

Oscilator Damper

In coping with unstable medium flow (pressure) at the entrance of flowmeters to ensure steady, reliable and en durable functioning, hi-tech. oscilation dampers is recommended to be installed on respective measuring components of the devices when measuring clean gases.

По вопросам продаж и поддержки обращайтесь:

Архангельск (8182)63-90-72
Астана +7(7172)727-132
Астрахань (8512)99-46-04
Барнаул (3852)73-04-60
Белгород (4722)40-23-64
Брянск (4832)59-03-52
Владивосток (423)249-28-31
Волгоград (844)278-03-48
Вологда (8172)26-41-59
Воронеж (473)204-51-73
Екатеринбург (343)384-55-89
Иваново (4932)77-34-06
Ижевск (3412)26-03-58
Иркутск (395) 279-98-46
Киргизия (996)312-96-26-47

Казань (843)206-01-48
Калининград (4012)72-03-81
Калуга (4842)92-23-67
Кемерово (3842)65-04-62
Киров (8332)68-02-04
Краснодар (861)203-40-90
Красноярск (391)204-63-61
Курск (4712)77-13-04
Липецк (4742)52-20-81
Магнитогорск (3519)55-03-13
Москва (495)268-04-70
Мурманск (8152)59-64-93
Набережные Челны (8552)20-53-41
Нижегород (831)429-08-12
Казахстан (772)734-952-31

Новокузнецк (3843)20-46-81
Новосибирск (383)227-86-73
Омск (3812)21-46-40
Орел (4862)44-53-42
Оренбург (3532)37-68-04
Пенза (8412)22-31-16
Пермь (342)205-81-47
Ростов-на-Дону (863)308-18-15
Рязань (4912)46-61-64
Самара (846)206-03-16
Санкт-Петербург (812)309-46-40
Саратов (845)249-38-78
Севастополь (8692)22-31-93
Симферополь (3652)67-13-56
Таджикистан (992)427-82-92-69

Смоленск (4812)29-41-54
Сочи (862)225-72-31
Ставрополь (8652)20-65-13
Сургут (3462)77-98-35
Тверь (4822)63-31-35
Томск (3822)98-41-53
Тула (4872)74-02-29
Тюмень (3452)66-21-18
Ульяновск (8422)24-23-59
Уфа (347)229-48-12
Хабаровск (4212)92-98-04
Челябинск (351)202-03-61
Череповец (8202)49-02-64
Ярославль (4852)69-52-93